

PRECO[®]
ELECTRONICS

MEKRA
LANG Germany



Operating manual

Management change assistant 1312 – PreView Side Defender II[®]

List of contents

1	Introduction	4
1.1	General points	4
1.2	Applicability	4
1.3	Manufacturer and distribution	5
1.4	Right to make changes	6
1.5	Storage and location of the operating manual	6
1.6	Explanation of technical terms, acronyms, abbreviations	7
2	Safety.....	8
2.1	Graphical & typographical conventions	8
2.1.1	Warning and safety instructions in this operating manual	8
2.1.2	Information concept	10
2.2	General points	11
2.3	Limits of the device	12
2.4	Qualification of users.....	13
2.5	Special advice for users with health restrictions	13
2.6	Intended use of the device	14
2.7	Use contrary to the intended purpose	15
2.8	Duty of care of the user	16
2.9	Safety systems and precautions	16
2.10	Special ambient conditions	16
2.11	Criteria indicating an existing or imminent malfunction of the device	17
2.12	Warranty notes and modification of the device	17
3	Product description	18
3.1	Items supplied	18
3.1.1	Items supplied for the AAS-GPS	18
3.1.2	Items supplied for the AAS-CAN	19
3.2	Product specifications	20
3.3	Technical data	21
3.3.1	Sensor 3.4 m AAS (081312001099).....	21
3.3.2	Cable harness SD 1 m / RCA 3 m (091312002099).....	22
3.3.3	Cable harness SD 7.4 m AAS (091312001099)	22
3.3.4	GPS (241312001099) & CAN (241312002099) displays	23
3.3.5	GPS antenna AAS (231312001099)	24
3.4	Functional description	25
3.5	Configuration.....	28
3.5.1	Overview	28
3.5.2	Schematic view of the AAS-GPS	29
3.5.3	Schematic view of the AAS-CAN	30
3.6	Controls and display	31

4	Transport and storage	33
5	Installation and commissioning	34
5.1	Installation.....	34
5.1.1	General points	36
5.1.2	Connecting to the system and wiring	37
5.1.3	Installing the sensor	40
5.1.4	Installing the display	44
5.1.5	Installing the GPS antenna (AAS-GPS only)	45
5.2	Removal.....	46
5.3	Setting up the device.....	46
5.4	Functional test.....	46
5.5	Commissioning	48
6	Operation	49
6.1	Normal operation.....	49
6.1.1	General points	49
6.1.2	Urban traffic mode.....	50
6.1.3	Cruising speed mode.....	50
6.1.4	Muting	50
6.2	Control and monitoring	51
6.3	Unusual situations.....	52
7	Troubleshooting	53
8	Care and maintenance	56
9	Final disposal	57
10	Service	58
10.1	Customer service.....	58
10.2	Accessories and consumables	58
10.3	Replacements and spares.....	58

1 Introduction

1.1 General points

This technical document describes the operation, troubleshooting and maintenance of the PreView® Side Defender®II AAS-GPS 611312002099 and AAS-CAN 611312001099 devices. It also contains safety instructions, general information about the product and instructions for installation. Detailed information on installation, which must always be carried out by a specialist workshop trained by MEKRA Lang, can be found in the installation manual.

The target group of this technical document are the vehicle drivers who have been instructed in the use of the PreView® Side Defender®II as well as technical personnel in the field of automotive engineering. Drivers must have the qualifications and aptitude to drive the motor vehicle.

If one of the terms "PreView® Side Defender® II", "Side Defender® II" "PreView® System", "turning assistant", "turning assistant system", "system", "object detection system", or "the device" is used in this operating manual without further specification, this refers to both the AAS-GPS 611312002099 and the AAS-CAN 611312001099. Information that refers to only one of the two models is expressly identified as such by referring to the respective model in the corresponding heading, in the copy text, in a table or in an illustration.

Where this operating manual refers to the "user" or "operator" of the system, this refers to the driver of the vehicle.

Please read this operating manual carefully before installing and using the Turning Assistance System to familiarise yourself with the product. Note in particular the information in Chapter 2.

1.2 Applicability

The document delivered with the product is considered to be the applicable version. That version applies to these products:

- AAS-GPS 611312002099 and
- AAS-CAN 611312001099.

1.3 Manufacturer and distribution

Placing on the market in the European Union by MEKRA Lang GmbH & Co.KG

Buchheimer Str. 4,
91465 Ergersheim
Germany

Phone +49 9847 989 0
Fax +49 9847 989 112
info@mekra.de
www.mekra.de

Distributed by members of the MEKRA Lang Group of companies

Buchheimer Str. 4,
91465 Ergersheim
Germany

Phone +49 9847 989 8076
Fax +49 9847 989 8120
technik@mekratronics.de
www.mekratronics.de

Developed by PRECO Electronics®

10335 W. Emeralds St.
Boise, Idaho 83704
USA

Phone +1 (866) 977 7326
www.preco.com

The names of actual companies and products mentioned in this document may be trademarks of their respective owners. All rights not expressly granted in this document are reserved.

1.4 Right to make changes

PRECO Electronics® and MEKRA Lang reserve the right to modify the product without prior notice.

The information contained in this operating manual is the technical specifications released at the time of publication of the manual. Significant changes will be taken into account in a new edition of the operating manual.

The document number and the revision number of this operating manual can be found on the last page of this document.

This document may be amended, corrected or expanded to take account of progress in sensor development. The latest version is available at www.mekra.de/.

1.5 Storage and location of the operating manual

This operating manual and all other applicable documents must be kept within easy reach and accessible at all times for later use.

This manual must be kept in a safe place and consulted during maintenance and/or reinstallation of the system.



The operating manual must be kept in a safe place and must always be carried in the vehicle.

1.6 Explanation of technical terms, acronyms, abbreviations

Technical terms

Azimuth field of view:	Horizontal detection zone
Elevation field of view:	Vertical detection zone
Target resolution:	Ability of a radar device to resolve multiple objects that are close together as separate targets and report them both individually. The required minimum distance between the objects is specified.

Abbreviations

BIST:	Built-in-safe test: continuous integrated self-test function
FMCW:	Frequency-modulated continuous-wave technology
FOPS:	Falling object protective structures: protective structures designed to protect the device against objects falling from above
KBA:	German Federal Motor Transport Authority
LNA:	Low-noise amplifier
RHCP:	Right hand circular polarisation of electromagnetic waves
ROPS:	Roll over protective structures
VSWR:	Voltage standing wave ratio

2 Safety

2.1 Graphical & typographical conventions

2.1.1 Warning and safety instructions in this operating manual

This section contains an overview of the symbols and safety instructions used.

In this operating manual, warning notices are presented as follows.

Section-specific warnings

Section-specific warnings refer to entire chapters, sections or paragraphs within this technical manual. Section-specific warnings are structured according to the following model:



Warning of a danger point

Consequences

> Actions

> Actions

In-line warnings

In-line warnings refer to a specific part within a paragraph. These warnings apply to smaller information units than the section-specific warnings. In-line warnings are illustrated in this technical document according to the following model:

 **DANGER! ACTION TO BE TAKEN TO AVOID A DANGEROUS SITUATION.**

Action to be taken to avoid a dangerous situation.



Signal words

The following signal words are used:

Signal word	Meaning
DANGER!	Indicates an immediate hazard which, if not avoided, will result in death or serious injury.
WARNING!	Indicates an immediate hazard which, if not avoided, could result in death or serious injury.
CAUTION!	Indicates an immediate hazard which, if not avoided, may result in minor injury.
NOTE!	Indicates a potential hazard which, if not avoided, may result in damage to property.

Pictographs

This operating manual uses pictographs to warn of hazards:

Pictograph	Meaning
	Warning of a danger point or dangerous situation
	Warning of dangerous electrical voltage
	Warning of non-ionising radiation

2.1.2 Information concept

Information is provided to simplify certain processes and enable the content to be grasped as quickly as possible. In this operating manual they are structured as follows:



Important information.

2.2 General points

WARNING!



Danger to life and serious physical injury and damage to property.

There is a danger to life, of serious physical injury and damage to property if all warnings, cautions and instructions are not correctly adhered to.

> Adhere to all the warnings, cautions and instructions contained in this operating manual.

WARNING!



Danger to life and serious physical injury and damage to property.

There is a danger to life, of serious physical injury and damage to property if the device is incorrectly installed. This may cause the system to malfunction, causing the driver to perform manoeuvres that endanger him or her, any passengers and other road users.

> The installation instructions given in Chapter 5.1 of this operating manual as well as the installation instructions must be observed in full and without fail.

Installation, assembly and electrical connection may only be carried out by a trained specialist in accordance with the information in this operating manual (see Chapter 5.1) and in accordance with the information in the installation manual. The PreView® Side Defender II must be installed in such a way that it cannot be shut down manually by the driver. Among other things, it must not be possible to switch off the turning assistant using the main electrical cut-off switch. The system must be activated when the ignition is switched on. The turning assistant may only be operated after proper installation.

WARNING!



Danger to life and serious physical injury and damage to property.

There is a danger to life, of serious physical injury and damage to property due to the operation of the system if it is not ready for operation or if it malfunctions. This can cause the driver to perform driving manoeuvres that endanger him or her, any passengers and other road users.

> The installation instructions given in Chapter 5.1 of this operating manual and the assembly instructions must be observed in full and without fail.

> Carry out the function tests according to Chapter 5.4 of this operating manual before each journey.

> Make sure that the status LED of the display is green (i.e. system ready for operation).

The AAS-GPS / AAS-CAN is a state of the art system. It may only be operated in a ready-for-use condition and in compliance with this operating manual. The system may only be used after a previous function check, i.e. the system must be checked for visible defects and functional readiness before each use (see also Chapter 5.4). Should any defects impair the function, they must be remedied before further use. The user is responsible for using the device in accordance with the intended purpose.

2.3 Limits of the device

AAS-GPS 611312002099

The housings of the sensor, display and GPS antenna represent the outer limits of the device. Since the cables are also components of the device, the sheathing of the connecting cables also forms the outer limits of the turning assistant system. The connections to the on-board electronics on the wiring harness SD 1 m / RCA 3 m (reverse signal, Aux out, CAN high, CAN low) as well as on the cable harness SD 7.4 m AAS (power supply, ground, indicator signal right) form the limits of the device on the vehicle side, even if not all of these wires need to be connected. For the assignment of the connecting leads, see Chapter 5.1.2, for the configuration of the turning assistant system, see Chapter 3.5.2.

AAS-CAN 611312001099

The housings of the sensor and GPS antenna represent the outer limits of the device. Since the cables are also components of the device, the sheathing of the connecting cables also forms the outer limits of the turning assistant system. The connections to the on-board electronics on the wiring harness SD 1 m / RCA 3 m (reverse signal, Aux out, CAN high, CAN low) as well as on the cable harness SD 7.4 m AAS (power supply, ground, indicator signal right) form the limits of the device on the vehicle side, even if not all of these wires need to be connected. For the assignment of the connecting leads, see Chapter 5.1.2, for the configuration of the turning assistant system, see Chapter 3.5.3.

2.4 Qualification of users

WARNING!



Danger to life and serious physical injury and damage to property.

There is a danger to life and of serious physical injury to vehicle occupants and other road users as well as a danger of damage to vehicles if the driver fails to comply with the road traffic regulations.

> Road traffic regulations must be followed in full at all times. This applies in particular with regard to the use of the exterior mirrors and looking over one's shoulder when turning corners, turning round and changing lanes.

The driver must be authorised to drive the vehicle and must have read this manual carefully and understood it. In addition, he or she must be fit to drive, i.e. he or she must not be under the influence of alcohol, drugs or narcotics or exceed the legally prescribed driving times. The turning assistant can neither compensate for nor replace lack of qualification or fitness to drive the vehicle.

2.5 Special advice for users with health restrictions



It is not possible to use the turning assistant system if you have impaired vision or hearing. This also applies if you have a red/green deficiency.

Individuals who are not able to recognise and distinguish the images on the display even with permanently worn glasses must not use the turning assistant system. This may be the case, for example, with people with a red-green colour deficiency or who have severely impaired vision.

Individuals whose hearing is so impaired that they can not hear the audible alert signals on the display or cannot distinguish them from other ambient sounds must not use the turning assistant system.

2.6 Intended use of the device

WARNING!



Danger to life and serious physical injury and damage to property.

There is a danger to life and of serious physical injury to vehicle occupants and other road users as well as a danger of damage to vehicles if the driver fails to comply with the road traffic regulations.

> Road traffic regulations must be followed in full at all times. This applies in particular with regard to the use of the exterior mirrors and looking over one's shoulder when turning corners, turning round and changing lanes.



When fitted to semi-trailer tractors, the turning assistant may trigger false alarms when the vehicle is traversing a tight bend with a semi-trailer. In this case, we recommend that you purchase additional accessories from your dealer to monitor the traffic situation more precisely.

The product does not pose any danger to persons, property or the environment if it is used for its intended purpose and the conditions and requirements specified in this operating manual and in the installation manual are observed and the warnings attached to the product are observed. This applies throughout the entire life cycle from delivery, installation in the vehicle and operation to dismantling and disposal.

Intended use is defined as installation and operation in accordance with the information in this operating manual and in the installation manual. In addition, a final assessment and an entry in the vehicle documents by a body accredited by the German Federal Motor Transport Authority may be required before use.

The turning assistant system is intended for use in heavy commercial vehicles over 3.5 t (lorries, buses, refuse collection vehicles, etc.) to draw attention to road users who are in the danger zone in the blind spot beside the vehicle. It is intended to be used as an aid for right-hand turns at intersections. It also provides alerts, within the detection range of the system, of road users who are in a defined area to the right of the vehicle. The PreView Side Defender®II can detect moving bicycles, motorcycles and other cars / lorries and, depending on speed, also pedestrians walking in the detection zone.

The turning assistant system does not relieve the driver of his or her responsibility to assess the situation and decide whether it is safe to move off, turn round or turn a corner.

2.7 Use contrary to the intended purpose

Use contrary to the intended purpose is considered to be if the turning assistant is used in a manner other than that described in Chapter 2.6 Intended use of the device. Use under the following conditions and circumstances in particular (this list is not exhaustive) is contrary to the intended use:

- Use as a substitute for one's own compliance with traffic regulations, one's own duty of care and overview of the traffic situation
- Use as a replacement for other mandatory assistance systems and vehicle equipment such as exterior mirrors
- Use for detecting stationary or very slowly moving objects and pedestrians
- Use by non-qualified users (see Chapters 2.4 and 2.5)
- Use when the device is exhibiting obvious malfunction (see Chapter 2.11)
- Use if the installation instructions in this operating manual and in the installation manual have been disregarded during installation (see Chapter 5.1.)
- Use outside motor vehicles.

2.8 Duty of care of the user

WARNING!



Danger to life and serious physical injury and damage to property.

There is a danger to life and of serious physical injury to vehicle occupants and other road users as well as a danger of damage to vehicles if the driver fails to comply with the road traffic regulations.

> Road traffic regulations must be followed in full at all times. This applies in particular with regard to the use of the exterior mirrors and looking over one's shoulder when turning corners, turning round and changing lanes.

The PreView® Side Defender II is a blind spot collision warning system designed to supplement other safety practices and/or devices. The device operator, i.e. the driver of the vehicle, always bears the responsibility for safe operation of the vehicle. The turning assistant can neither compensate for nor replace a lack of care when driving the vehicle.

2.9 Safety systems and precautions

The system is protected against overload by an overvoltage protection unit integrated in the sensor.

The radar sensor has a continuous built-in self-test function (BIST) that reports any system failures to the operator via the display in the cab within fractions of a second.

2.10 Special ambient conditions

WARNING!



Danger to life and serious physical injury and damage to property.

There is a danger to life, of serious physical injury and damage to property due to the operation of the system if it malfunctions or if signals are not correctly interpreted. This can cause the driver to perform driving manoeuvres that endanger him or her, any passengers and other road users.

> Under special environmental conditions, exercise increased vigilance and scepticism towards the audible and visual alerts of the turning assistant.

The following environmental conditions may cause the system to fail to report a fault or may cause difficulties in detecting turning assistant signals:

- A dirty or salty environment or salt spray can limit the functionality of the radar sensor and lead to false alerts (see also Chapters 2.11 and 7).
- In direct sunlight it is possible that the LEDs of the display will be difficult to distinguish (see also Chapter 5.1.4).

2.11 Criteria indicating an existing or imminent malfunction of the device

The display will indicate malfunctions of the PreView® Side Defender II by visual signals. Possible malfunctions and ways to remedy them are described in Chapter 7.

Further information indicating an existing or imminent malfunction of the system:

- Dirt on the radar sensor (see also Chapter 5.4)
- Loose, chafing, dangling cables and connections of the turning assistant or in contact with it (see also Chapter 5.4)
- Obstacles in the detection zone of the radar sensor (see also Chapter 5.1)

2.12 Warranty notes and modifications to the device

The warranty period is 24 months.

The individual components may not be opened, modified or altered in any way.

 **WARNING!** Do not open, modify or change any of the components of the turning assistant system, as otherwise there is a risk of malfunction or damage to the system. This can cause the driver to perform driving manoeuvres that endanger him or her, any passengers and other road users.

3 Product description

3.1 Items supplied

3.1.1 Items supplied for the AAS-GPS

Illustration	Designation	Item number
	Sensor 3.4 m AAS	1* Item no. 081312001099
	Wiring harness SD 7.4 m AAS	1* Item no. 091312001099
	Wiring harness SD 1 m / RCA 3 m	1* Item no. 091312002099
	GPS display (G2000)	1* Item no. 241312001099
	GPS antenna AAS	1* Item no. 231312001099
	User manual	1* Item no. 031312001000

3.1.2 Items supplied for the AAS-CAN

Illustration	Designation	Item number
	Sensor 3.4 m AAS	1* Item no. 081312001099
	Wiring harness SD 7.4 m AAS	1* Item no. 091312001099
	Wiring harness SD 1 m / RCA 3 m	1* Item no. 091312002099
	CAN display (D2002)	1* Item no. 241312002099
	User manual	1* Item no. 031312001000

3.2 Product specifications

The PreView[®] Side Defender II is intended for commercial use.

At the date of publication of this operating manual, this device complies with the following regulations valid in the European Union:

- ETSI EN300 440-1 Electromagnetic Compatibility and Radio Spectrum Matters

Further information can be found in the Declaration of Incorporation (Chapter 11).

3.3 Technical specifications

3.3.1 Sensor 3.4 m AAS (081312001099)

General points

Transmitter	FMCW radar at 24 GHz narrow band
Connector:	DEUTSCH DT06-08SA-
Ingress protection:	IP69K
Housing material:	Polycarbonate radome
Dimensions:	12.4 cm x 10.3 cm x 3.25 cm H x W x D
Weight	0.45 kg
Operating temperature:	-40 °C to +85 °C
Storage temperature	-55 °C to +105 °C
Vibration resistance:	25 G, random, three axes
Shock resistance:	50 G
Fitting:	Four mounting holes with a diameter of 5.6 mm

Operating characteristics

Detection zone:	
• Stationary:	3 m x 10 m D x W
• In motion:	3 m x 12 m D x W
Range accuracy:	0.3 m
Azimuth field of view:	± 85° (10 dB/m ² target)
Elevation field of view:	± 10° (10 dB/m ² target)
Angular accuracy:	± 2° for ± 10° field of view, ± 5° for ± 30° field of view, ± 10° for ± 75° field of view
Speed range:	± 30 m/s

Speed accuracy:	0.2 m
Target resolution:	For static targets about 1.4 m For dynamic targets about 0.3 m
Cycle time:	120 ms
Target acquisition time:	300 ms
Activation time:	300 ms

Electrical characteristics

Frequency:	24.00-24.25 GHz
Power supply:	9-33 VDC, reverse polarity protected and overvoltage protected
Power consumption:	< 0.5 A

Communication interface

J1939 CAN bus:	250 kbit/s, not terminated
Auxiliary output Aux Out:	Active - connected to ground, discharge up to 1 A, overcurrent protected inactive - high impedance
Certificates	CE, RoHS, E11, FCC

3.3.2 Wiring harness SD 1 m / RCA 3 m (091312002099)

Length	1.0 m
--------	-------

3.3.3 Wiring harness SD 7.4 m AAS (091312001099)

Length	7.4 m
--------	-------

3.3.4 Display GPS (241312001099) & CAN (241312002099)

General points

Connector	CONXALL 6280-8SG
Ingress protection:	
GPS (G2000):	IP54
CAN (D2002):	IP67
Housing material:	Polycarbonate
Dimensions:	Ø 50 mm x 27 mm, excluding holder
Operating temperature:	-40°C to +85°C
Storage temperature:	-55°C to +105°C
Vibration resistance:	10 G, random, three axes
Fitting:	Via bracket on A-pillar on right of vehicle
Volume level:	Max. 85 dB(A) at 10 cm in front of speaker

Electrical characteristics

Power supply:	Via radar sensor
---------------	------------------

Communication

Physical layer:	CAN 2.0B, 250 KB/s
Protocol layer:	SAE J1939 Extended
Data update rate:	120 Ms

Operating characteristics

Warning levels:	
	Right indicator inactive: Two LEDs light up yellow (No. 2 & 4)
	Right indicator active: Two LEDs light up yellow (No. 2 & 4)
	Two LEDs light up red (No. 1 & 5)
	Additional audible alert

3.3.5 GPS antenna AAS (231312001099)

General points

Dimensions:	32.7±2 mm x 43.3±2 mm x 14±1 mm
Ingress protection	IP67
Cable length:	3 m
Connector type:	SMA (M) straight

Ceramic chip specifications

Dimensions/ base size	25*25*4 mm
Mean frequency	1575.42 ±3 MHz
Bandwidth	10 MHz
VSWR	1.92 max
Axial ratio	3 dB typ.
Gain @ Zenith	2 dBic typ.
Impedance	50 Ω
Polarisation	RHCP

LNA specifications

Frequency	1575.42 MHz
Impedance	50 Ω
VSWR	1.92 max.
Gain	30 dB typ.
Gain at connector	28.4 dB U (with cable attenuation for 3 m cable length)
Input voltage	2.7 A at 5 V
Noise figure	1.5 dB typ.
Current consumption	4.7 mA at 2.7 V; 6 mA at 3.3 V; 10.3 mA at 5 V
Operating temperature	-40 °C to +85 °C
Storage temperature	-40°C to +90°C

3.4. Functional description

The PreView Side Defender®II is a small, rugged short-range radar sensor designed and made by PRECO Electronics® in the USA. It is for use in heavy-duty applications such as lorries, buses, refuse vehicles and other applications requiring a robust, high-performance radar for detecting objects in the side blind-zone. The sensor transmits and receives low power narrow band 24 GHz radar signals. It then processes the returned signals to determine if an object has reflected any energy back to the sensor and determines if the object is moving.

Using frequency-modulated continuous-wave (FMCW) technology, the radar sensor measures radial range, speed, angle, reflectivity, and other parameters of several stationary and moving targets simultaneously. This radar sensor has a wide horizontal field of view up to +/-85°, optimised for side object detection in large lorries and buses. The horizontal field-of-view is approximately 12 m along the vehicle side and extends approximately 3 m from the side of the vehicle.

The radar sensor has a continuous built-in self-test function (BIST) that reports any system failures to the operator via the display in the cab within fractions of a second. This function monitors transmission and reception power as well as internal operating procedures. The built-in self-test (BIST) reporting function is a critical feature for fail-safe operation.

If an object is moving and poses a potential risk of collision, this is indicated visually on the operator display in the form of LED indicators. The PreView Side Defender®II can detect moving bicycles, motorcycles and other cars / lorries and, depending on speed, also pedestrians walking in the detection zone. Stationary objects such as crash barriers, parked cars and pedestrians standing at the side of the road or moving very slowly are ignored. Thanks to the design of the technology, the sensor processes and reports the detection within 300 ms, so that it can respond quickly to objects in the detection zone. False alarms caused by stationary objects (such as crash barriers and parked cars) are reduced to a minimum.

If the direction indicator is active, a one-off audible alert is also given. The visual alert indicator remains active as long as the sensor detects a hazard. No distinction is made between different potential hazards - the alert is a general one.

The effectiveness of the Side Defender®II radar sensor is not negatively affected by any other PreView® radar or similar sensors operating very close to it.

The PRECO PreView Side Defender®II turning assistant, AAS, fulfils the recommendations of German Transport Gazette (Verkehrsblatt) Vol. 19 - 2018; no. 149, if it has been properly assembled and installed.

The turning assistant, AAS-GPS /-CAN is based on the PRECO PreView Side Defender®II FMCW radar sensor.

Speed message

The PreView Side Defender® II is designed to receive a vehicle speed message on the PreView® display.

AAS-GPS: The speed signal is transmitted via the integrated GPS sensor of the G2000 display. It is essential to fit an additional external GPS antenna to ensure reliable reception of the GPS signal in the open air.

AAS-CAN: The D2002 display has an integrated CAN interface. It has inherent support for certain J1939 vehicle speed messages transmitted by the vehicle CAN bus. Contact MEKRA Lang® or PRECO Electronics® for more information on the potential applications of this function.

Direction indicator input signal

For proper in-cab display operation, Side Defender® II requires a turn signal input. If the direction indicator is active, the display emits an audible alert when an object is detected. Further information can be found in the wiring diagrams in Chapter 5.1.

Reverse gear input signal

For proper in-cab display operation, Side Defender® II requires a reverse signal input. This ensures that the system works safely in both forward and reverse gear. Further information can be found in Chapters 3.5 and 5.1.

Auxiliary output

The Side Defender® II radar sensor supports an auxiliary output signal that can be used to provide additional alerts.

This output is an active low (switch to ground). One example use of this output is to drive an LED indicator in a side mirror when there is an object in the side blind zone. Contact MEKRA Lang® or PRECO Electronics® for more information.

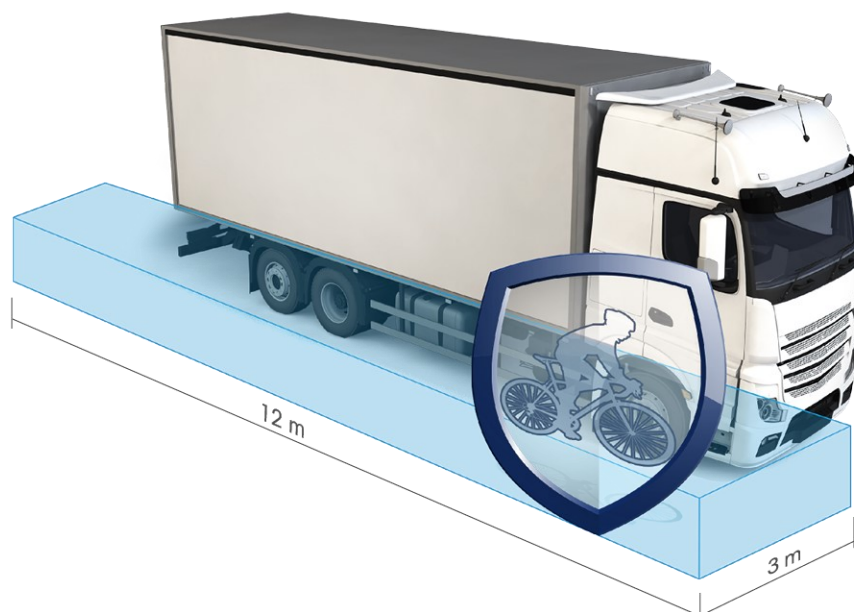

The PreView Side Defender®II can detect most objects in the detection zone. However, there are circumstances in which objects can evade detection. The size, shape, orientation, relative position and composition of an obstacle are factors that determine whether an object is detected when and where. The Side Defender®II radar sensor transmits low-power electromagnetic energy. Any energy that strikes an object reflects a certain amount of this energy back to the Side Defender®II radar sensor. If the returned energy is of sufficient magnitude, it is used to indicate the presence of an object and determine the object's distance.

The Side Defender®II then uses the vehicle speed message to determine whether the detected object is in motion or stationary. While PreView® sensors can resolve multiple objects, only the detected object in motion closest to the vehicle is reported by the operator display since it represents the most significant collision threat.

The amount of energy that is reflected back depends on various factors:

- Size - a larger object usually reflects more energy than a smaller object.
- Composition - a metal object usually reflects more energy than an object that is not made of metal.
- Scattering - a solid object reflects more energy than a non-solid object (examples of a non-solid object are branches, gravel, bushes, etc.).
- Shape - complex shapes cause energy to be returned in a very non-uniform way. Small variations or movement can change detection status.
- Angle – the flat side of an object perpendicular to the sensor will reflect more energy than an object at an angle. See Fig. 1 for an example of how angle can affect return energy.

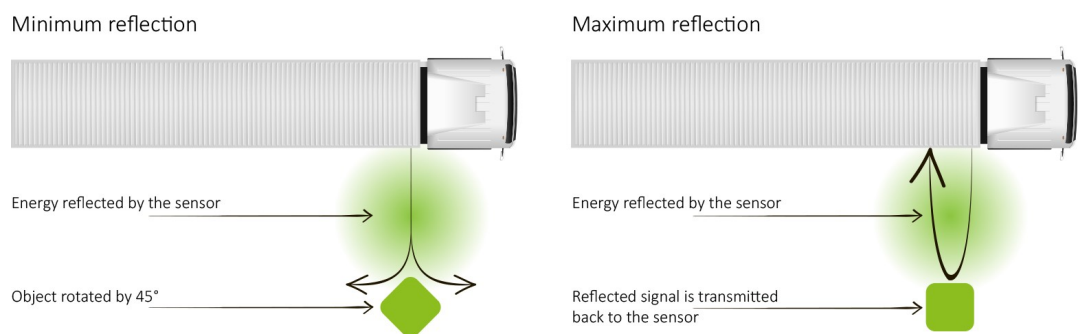

Fig. 1: Object reflection

3.5 Configuration

3.5.1 Overview

Chapters 3.5.2 and 3.5.3 schematically show the configuration of the PreView Side Defender®II AAS-GPS 611312002099 and AAS-CAN 611312001099. See Chapter 5.1 for the assignment of the connecting leads and plug connections.

Wiring harness SD 1 m / RCA 3 m

The wiring harness SD 1 m / RCA 3 m serves these purposes:

- the supply of the display GPS G2000 or CAN D2002
- the connection to the vehicle analogue signals and CAN
- the control of an additional alert device.

Wiring harness SD 7.4 m AAS

Wiring harness SD 7.4 m AAS is for supplying power to the

- radar sensor
- GPS or CAN displays.

3.5.2 Schematic view of the AAS-GPS

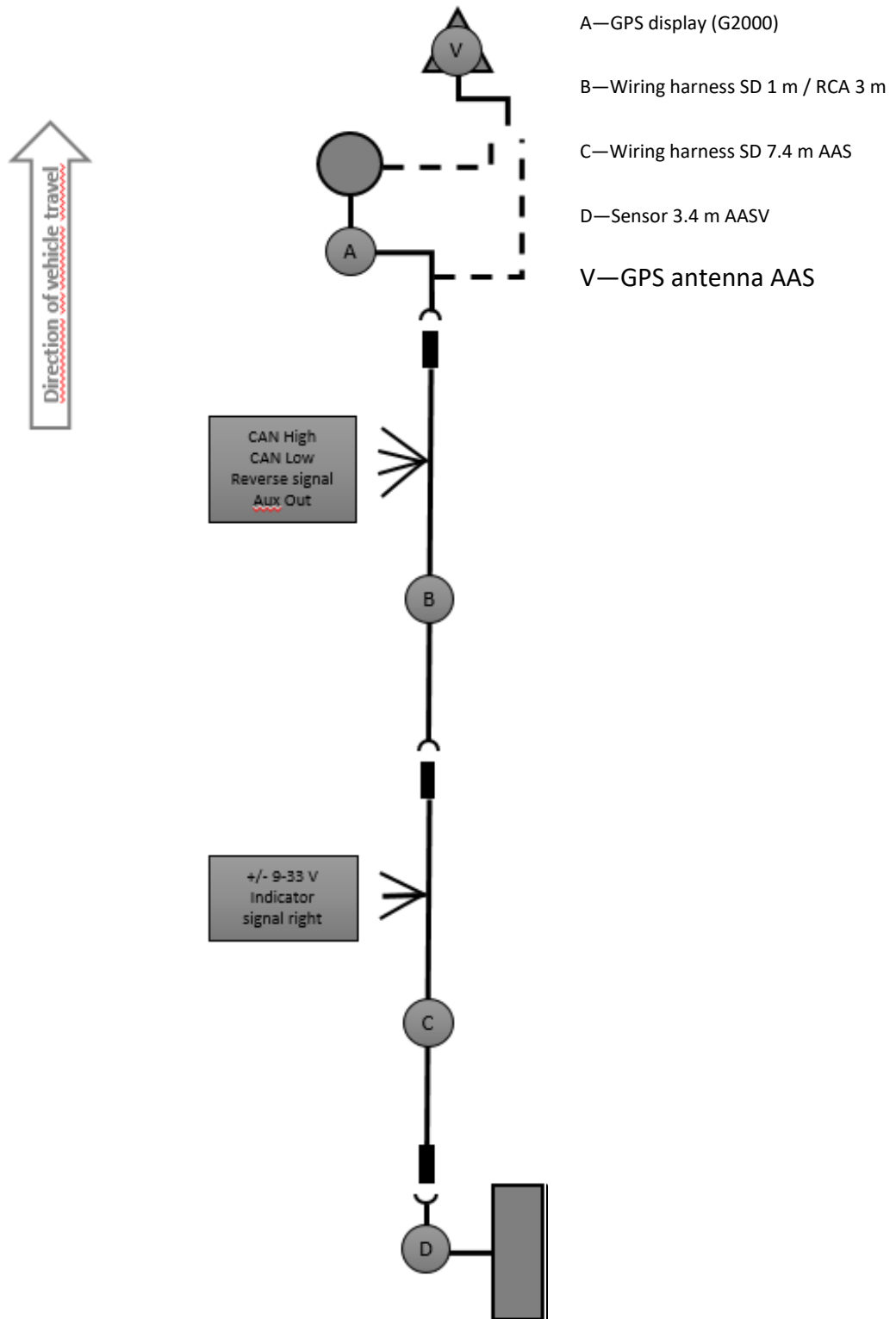

Fig. 2: Schematic view of the AAS-GPS

3.5.3 Schematic view of the AAS-CAN

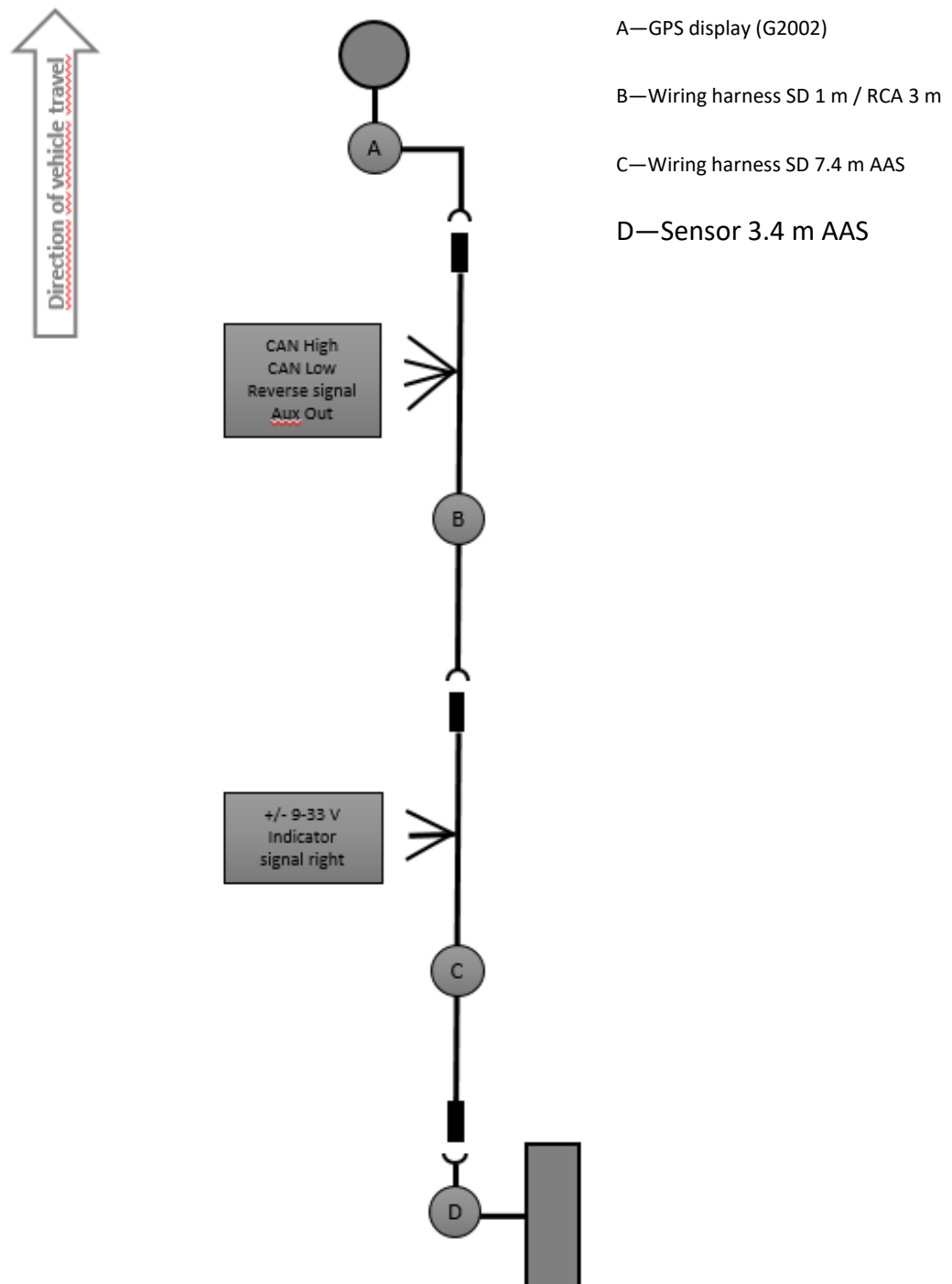

Fig. 3: Schematic view of the AAS-CAN

3.6 Controls and display

WARNING!



Danger to life and serious physical injury and damage to property.

There is a danger to life and of serious physical injury to vehicle occupants and other road users as well as a danger of damage to vehicles if the driver fails to comply with the road traffic regulations.

> Road traffic regulations must be followed in full at all times. This applies in particular with regard to the use of the exterior mirrors and looking over one's shoulder when turning corners, turning round and changing lanes.

The PreView® v2 D2002 and PreView® G2000 operator displays continuously monitor the signals transmitted by the PreView® sensors connected and notify the operator by means of a fault message in the event of failure, malfunction or blockage (see Chapter 7).

PreView® v2 D2002 - The PreView® v2 displays are general displays which are intended for use with all PreView® sensors that use the CAN protocol. These displays inform the operator by means of audible and visual alerts about a detected object's direction and distance. The D2002 indicates the detected objects via LEDs arranged around the outside of the display.

PreView® G2000 - In addition to the functions provided by the D2002, the G2000 can be used to determine vehicle speed via an external GPS antenna. CAN integration, however, is not possible.



Before starting a journey, the volume of the display must be adjusted by pressing the volume control so that the audible alert will be perceived by the driver while driving despite any secondary noise sources (radio, on-board radio communications, traffic noise, etc.) in such a way that the driver can safely operate the turning assistant system in the vehicle.

At the top of each display is a switch that allows the operator to adjust the volume to five different levels.

Sunlight can affect the readability of the LED displays.

If the direction indicator is active, the display emits an audible alert when an object is detected.

The system cannot be switched off. However, as an assistance system it cannot be a substitute for the driver's care and attention in road traffic.

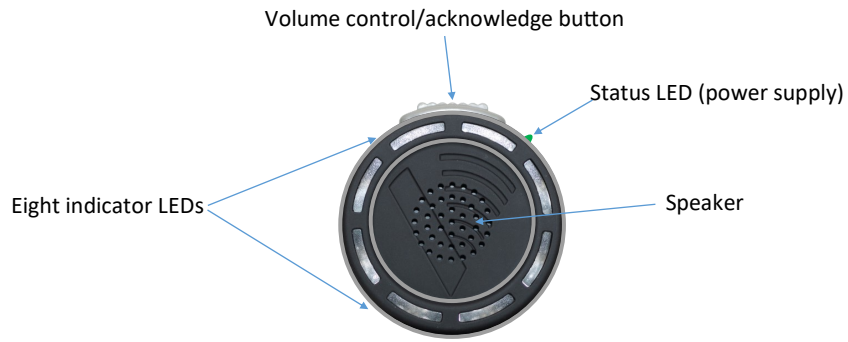

Fig. 4: Operator display

Components	Description
Status LED	Steady green after the system is turned on.
Speaker	The faster the audible alert signal is repeated, the closer the detected object is. The audible alert signal refers to the nearest detected object.
Indicator LEDs	These LEDs provide information on the operating status of the system and indicate any faults. Furthermore, alerts are visualised through the LEDs.
Volume control	The operator can select five different volume levels with this button. The last level selected is the one saved by the system.

4 Transport and storage

The PreView Side Defender®II should be stored and transported in such a way that it is protected against moisture and direct sunlight. It must be secured against falling when in transit. In all cases, the technical specifications must be observed (e.g. storage temperature, shock resistance, see Chapter 3.3).

5 Installation and commissioning

5.1 Installation

WARNING!



Danger to life and serious physical injury and damage to property.

There is a danger to life, of serious physical injury and damage to property if the device is incorrectly installed. This may cause the system to malfunction, causing the driver to perform manoeuvres that endanger him or her, any passengers and other road users.

> The installation instructions given in Chapter 5.1 of this operating manual as well as in the installation manual must be observed in full and without fail.

WARNING!



Danger to life and serious physical injury and damage to property.

There is a danger to life and of serious physical injury to vehicle occupants and other road users as well as a danger of damage to vehicles if the unit is not correctly connected to the vehicle direction indicators. This may cause the system to malfunction, causing the driver to perform manoeuvres that endanger him or her, any passengers and other road users.

> Ensure that the selected wire for the direction indicator is activated ONLY when the direction indicator is active and the operation-specific (non-diagnostic) signal is present.

On some lorries, the daytime running lights and/or the air brakes may activate the wire connected to the direction indicator.

WARNING!



Danger to life and serious physical injury and damage to property.

There is a danger to life and of serious physical injury to vehicle occupants and other road users as well as a danger of damage to vehicles if the PreView Side Defender®II unit is not correctly connected to the vehicle CAN bus. This can cause unpredictable and dangerous vehicle behaviour.

> The connection to the CAN communication of a vehicle may only be carried out by qualified personnel.

> DO NOT connect the PreView® Side Defender®II directly to the CAN bus of the vehicle. Always use the display as the gateway. The gateway ensures that only one-way communication from the vehicle CAN bus to the Side Defender®II is permitted. Do not allow PreView Side Defender®II J1939 messages to be transmitted on the vehicle CAN bus.

> If using a gateway to the vehicle CAN bus for the speed message, the vehicle CAN bus, PreView Side Defender®II and in-cab LED display must all use the same baud rate.

WARNING!



Danger to life and serious physical injury and damage to property.

There is a danger to life, of serious physical injury and damage to property when working on the on-board electronics.

> Adhere to good engineering practice

> Comply with all applicable safety rules:

1. Disconnect
2. Secure against restarting
3. Check to ensure all poles are voltage free
4. Ground and short circuit
5. Cover or fence off adjacent live parts

WARNING!



Danger of serious physical injury.

The risk of serious physical injury due to prolonged presence within the detection range of the radar sensor cannot be discounted.

> Avoid staying within the detection range of the radar sensor for hours while it is active.



The installation of the turning assistant system may only be carried out by a specialist workshop trained by MEKRA Lang in accordance with the manufacturer's installation manual.



For operation via CAN bus: the display D2002 CAN (241312002099) included in the scope of delivery of the AAS-CAN (611312001099) also functions as a gateway and ensures that only CAN data is read. It is not possible to write data to the vehicle CAN. A suitable connection must be provided by the vehicle manufacturer.



If wires in the supplied wiring harness have to be extended, a conductor cross-section of at least 0.75 mm² must be used.

The system is protected against overload by an overvoltage protection unit integrated in the sensor.



During installation, the vehicle and body manufacturer's guidelines must be observed. This also applies to specifications for ROPS/FOPS, where applicable.

5.1.1 General points

Before installing the PreView® object detection system, operators should familiarise themselves with the functionality and system components by thoroughly reading all accompanying documents.

Correct installation of this product in accordance with this manual is essential to avoid injury and possible death. Should the system fail, it could endanger the safety or lives of those who rely on the system.

For the correct installation of the object detection system, it is essential to have thorough knowledge of the power supply system of the device and the electrical procedures and to have the qualifications necessary for the installation.

5.1.2 Connecting to the system and wiring

Note!

Danger of damage to property.

Risk of damage to property if incorrectly installed

- > If lead-throughs are necessary on the cab or chassis, the vehicle manufacturer's specifications must be observed.
- > To ensure compliance with the intended purpose, ensure wiring is laid in such a way that it is protected against external influences.
- > Plug-in connectors must be correctly seated to ensure compliance with their ingress protection ratings.

System connections

The system must be connected to ignition plus and vehicle ground.

Make sure that the direction indicator that relates to the mounting side of the sensor is connected. As a rule, within the European Union in countries that drive on the right this means: fitting side for the sensor is the right - direction indicator signal is for the right.

The settings for the CAN bus can be found in the installation manual.

Wiring

The wires must be laid professionally and routed out of the vehicle cabin in accordance with the vehicle manufacturer's specifications. The wires must be laid in such a way that they cannot be damaged, for example by moving components or the effects of heat.

Refer to Chapter 3.5 for instructions on using wiring harnesses SD 1 m / RCA 3 m and SD 7.4 m AAS.

Wiring harness SD 1 m / RCA 3 m



Fig. 5: Wiring harness SD 1 m / RCA 3 m pin assignment

Assignment	
1. Connection strands	
Yellow	CAN high — listen only
Green	CAN low — listen only
Blue	Reverse gear signal
White	Aux out
1.1 CONXAL plug connection	
1	CAN high—Com. Sensor
2	CAN low—Com. Sensor
3	CAN high
4	CAN low
5	Power supply to display
6	Ground
7	Discrete output
8	Discrete input

Wiring harness SD 7.4 m AAS



If an additional external loudspeaker is to be installed to warn outside road users, it can be inserted in slot 7 of the DEUTSCH connector on the wiring harness (external loudspeaker and connecting cable not included in the scope of delivery).



Fig. 6: Wiring harness SD 7.4 m AAS

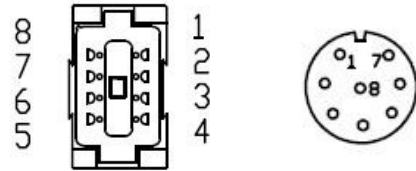

Fig. 7: Pin assignment for wiring harness SD 7.4 m AAS

Assignment	
1. Connection strands	
Red	Power supply 9-33 V
Black	Ground
Blue	Indicator signal right
1.1 DEUTSCH connector (to radar sensor)	
1—Red	Power supply 9-36 V
2—Black	Ground
3—Yellow	CAN high
4—Orange	CAN low
5—Green	Power supply to display
6—Brown	Display ground
7—Not assigned	External output for outdoor speaker, not assigned
8—Blue	Indicator signal right
1.2 CONXAL plug connection (to display)	
3—Yellow	CAN high
4—Orange	CAN low
5—Green	Power supply to display
6—Brown	Display ground

5.1.3 Installing the sensor

Position of the sensor



Metallic and other strong radar reflecting objects must remain outside of the keep out zones defined in Fig. 11. Radar reflecting objects within these areas may affect operation. If those objects cannot be removed, testing must be performed to determine the influence on the system's performance.



Before permanently installing the PreView Side Defender®II on the vehicle, verify that the selected sensor mounting location provides a clear detection zone. Take the vehicle to a clear area, temporarily attach the sensor in the proposed mounting location, apply power to the system, and run through the tests listed from Point 4 of the tests before starting a journey in Chapter 5.4.

For proper system operation, the exact positioning of the Side Defender®II is critical. The sensor should be fitted laterally, min. 3500 mm and max. 5000 mm from the front edge of the vehicle, with the underside of the radar no less than 600 mm and the upper side of the radar no more than 1000 mm above ground level. The vehicle's height levelling must be set to driving mode. The front of the sensor should be perpendicular to the ground so that the Side Defender®II label is facing up and the V logo is facing down.

A position with as little vibration as possible which provides a certain degree of protection against impact and contamination, while allowing an unobstructed view of the target area of interest must be chosen. For clearance specifications, refer to the description of the keep out & interference zones in Fig. 11 or the recommended sensor position on the vehicle in Fig. 8.

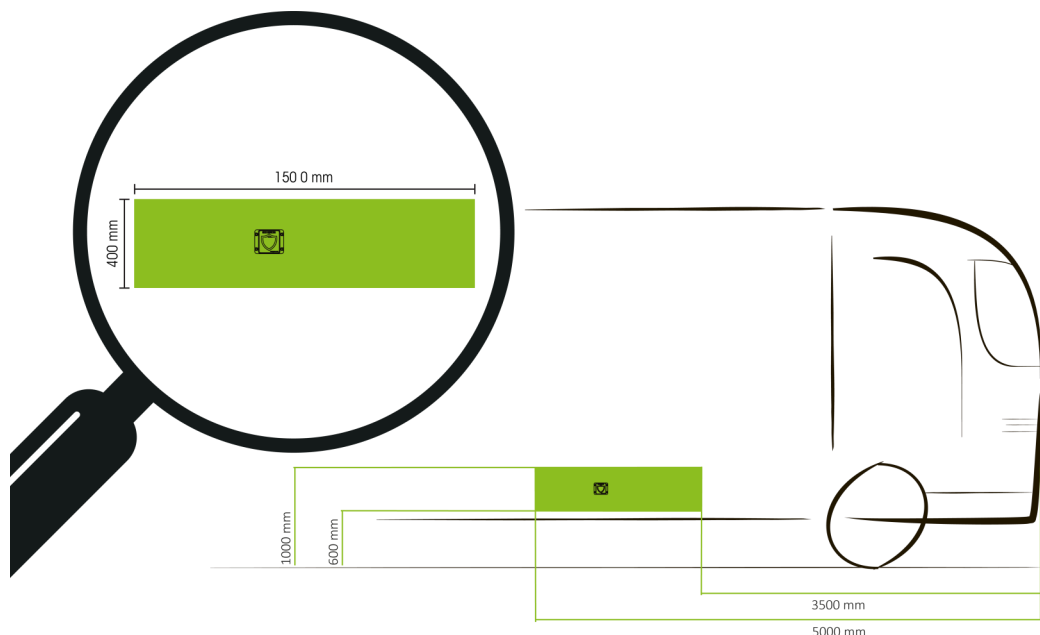

Fig. 8: Sensor position on the vehicle, installation clearances to be observed

The performance of the sensor can be negatively impacted if the sensor is angled down, causing ground and curb detections. Any time the sensor is not perpendicular to the ground, the performance should be tested.

The sensor's horizontal field of view is $\pm 85^\circ$ and the vertical field of view is $\pm 10^\circ$. For optimum performance, the sensor should protrude beyond any other portion of the vehicle.

As regards the installation position, the vehicle and body manufacturer's guidelines must be observed. In addition, the sensor should not be mounted directly on or near the exhaust pipe.

Fitting the sensor

1. Select the appropriate location to fit the sensor (see Fig. 8).
2. The standard fitting configuration is with the 'Side Defender®II' text facing up, as shown in Fig. 10.
3. Drill four holes $\varnothing 6$ mm as shown in Fig. 10.
4. For the pigtail, drill a $\varnothing 38$ mm hole for the sensor connector and mating connector.
5. Fasten the sensor to the fixture using the parts included in the scope of delivery, using a torque of 2.5 Nm.

Fitting tolerances

For optimum performance, the vertical angle (up/down) tolerances are $+5^\circ$ (up) and -2° (down). The horizontal angle (side/side) tolerance is $\pm 2^\circ$. It is also very important that the device is aligned perpendicular to the front of the vehicle, which should also be within a range of max. $\pm 2^\circ$ (see Figure 9).

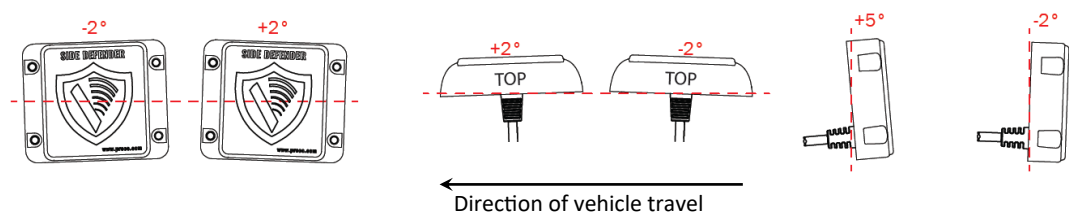

Fig. 9: Vertical and horizontal angle fitting tolerances

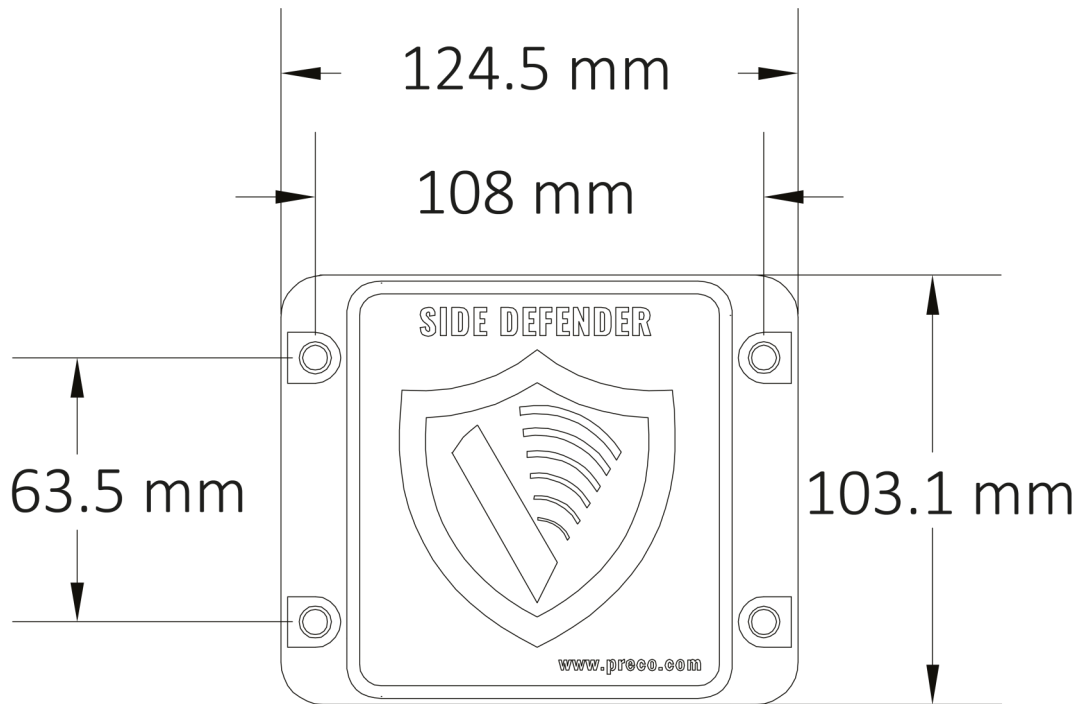

Fig. 10: Drilling dimensions of the sensor

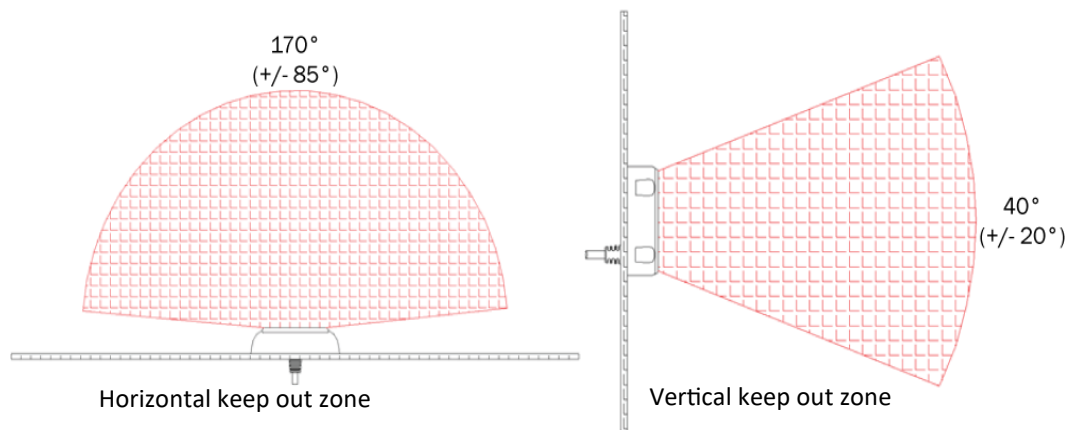
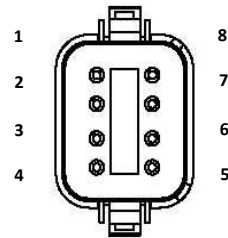

Fig. 11: Keep out zones



Fig. 12: Radar sensor with pin assignment

PIN	SIGNAL DESIGNATION
1	Power supply 9-33 V
2	Ground
3	CAN high
4	CAN low
5	Power supply to display
6	Display ground
7	External alert output
8	Input signal, indicator signal right



5.1.4 Installing the display



In the AAS-GPS & CAN turning assistant systems, only the right-hand LEDs 1 & 5 and 2 & 4 are active at any one time (driving on the right).

The display is to be mounted on the right A-pillar. The volume control should be facing upwards. See Fig. 13. Make sure that the display is rotated and tilted towards the driver at an optimum viewing angle using the display holder provided. During operation, the display LEDs must not be impaired by direct sunlight, which may prevent their interpretation.

The direct view to the outside and the indirect view via the exterior mirrors must not be obscured by the display. It must also be ensured that no display elements are covered.

Additional sensors (of the types Side Defender II or Sentry) which are available as accessories can be connected to the displays.



Before commissioning, the volume of the display must be adjusted by pressing the volume control so that the audible alert will be perceived by the driver while driving despite any secondary noise sources (radio, on-board radio communications, traffic noise, etc.) in such a way that the driver can safely operate the turning assistant system in the vehicle.

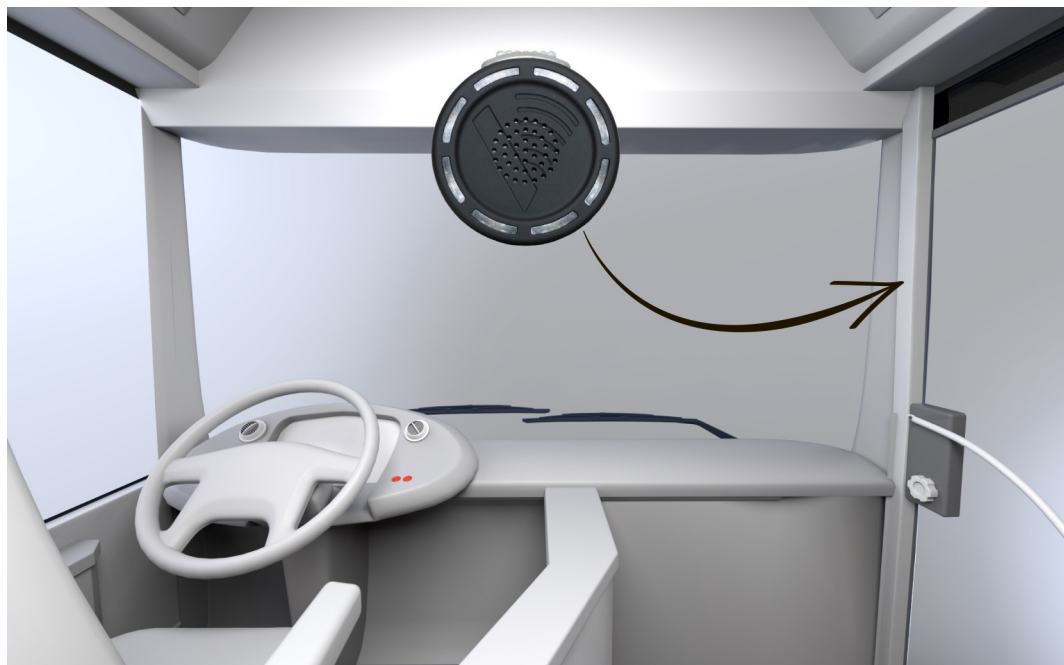

Fig. 13: Fitting position for the display

5.1.5 Installing the GPS antenna (AAS-GPS only)

The GPS antenna of the AAS-GPS must be permanently attached to the vehicle and must be installed in such a way that there is an uninterrupted view upwards.

The surface to which the antenna is to be attached must be free of grease and all dirt must be removed with a suitable cleaning agent before the gluing process. Care must be taken to ensure that the cleaning agent does not attack the paint.



Fig. 14: GPS antenna with pin assignment

PIN	SIGNAL DESIGNATION
1	Signal
2	Shielding

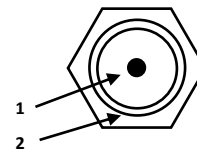

5.2 Removal

When removing the unit, the delivery condition must be restored. It is important to ensure that other vehicle systems are not damaged and remain fully functional after the removal of the turning assistant. During the removal process, the generally applicable installation instructions in Chapter 5.1 must be observed, especially the safety instructions.

5.3. Setting up the device



Before starting a journey, the volume of the display must be adjusted by pressing the volume control so that the audible alert will be perceived by the driver while driving despite any secondary noise sources (radio, on-board radio communications, traffic noise, etc.) in such a way that the driver can safely operate the turning assistant system in the vehicle.

At the top of each display is a switch that allows the operator to adjust the volume to five different levels.

Setting up the CAN bus must only be carried out by an authorised specialist workshop.

5.4 Functional test

WARNING!



Danger to life and serious physical injury and damage to property.

There is a danger to life, of serious physical injury and damage to property due to the operation of the system if it is not ready for operation or if it malfunctions. This can cause the driver to perform driving manoeuvres that endanger him or her, any passengers and other road users.

- > The installation instructions given in Chapter 5.1 of this operating manual as well as in the installation manual must be observed in full and without fail.
- > After initial commissioning and every time after the system has failed, the inspection of the detection zone according to Chapter 5.4 of this operating manual must be carried out.
- > Make sure that the status LED of the display is green (i.e. system ready for operation).

The radar sensor has a continuous built-in self-test function (BIST) that reports any system failures to the

operator during operation via the display in the cab within fractions of a second.

The proper functioning of the system must be ensured as part of the departure check before starting the

journey: the green status LED must light up and no error messages from the system (see Chapter 7) must be shown on the display.

Checking the detection zone

This test must be carried out by two people: the operator, who remains in the cab, and the assistant, who passes through the sensor field (the detection zone) next to the vehicle.

1. Move the vehicle to an open space that is larger than the detection zone to be tested
2. Remove dirt, mud, snow, ice or other residues from the front of the sensor.
3. Visually inspect the attached wiring and cable and verify that they are properly secured, not chafing or dangling free where they could become snagged and damaged. Inspect the PreView[®] sensor and operator display and verify that they are securely attached to the vehicle and do not show any signs of external damage.
4. Place the sensor in active mode. Make sure the vehicle has been secured and remains stationary.
5. Verify the sensor is operational: status LED shows green and an audible signal is heard.
6. Assure the detection zone has been cleared of all obstacles. Any obstacles in the detection zone will interfere with the test.
7. The assistant should walk towards the sensor while the operator notes when the warning activates, signifying the sensor has detected the assistant and identifying the detection zone limits.
8. Next, the assistant should walk from the centre of the sensor field straight back, away from the vehicle (the centre line of the detection zone) while the operator notes when the warning (notification) stops.
9. The assistant should move a metre to the left of the sensor and walk towards the sensor again while the operator notes the warning.
10. Repeat the above step by moving out another metre to the left and walking towards the sensor while the operator notes the warning.
11. Repeat this test sequence for the right side.
12. Finally, after the test, the operator and the assistant need to compare notes on the detection zone.

5.5 Commissioning

WARNING!



Danger to life and serious physical injury and damage to property.

There is a danger to life, of serious physical injury and damage to property due to the operation of the system if it is not ready for operation or if it malfunctions. This can cause the driver to perform driving manoeuvres that endanger him or her, any passengers and other road users.

- > The installation instructions given in Chapter 5.1 of this operating manual as well as in the installation manual must be observed in full and without fail.
- > Carry out the function tests according to Chapter 5.4 of this operating manual before each journey.
- > Make sure that the status LED of the display is green (i.e. system ready for operation).

WARNING!



Danger to life and serious physical injury and damage to property.

There is a danger to life and of serious physical injury to vehicle occupants and other road users as well as a danger of damage to vehicles if the driver fails to comply with the road traffic regulations.

- > Road traffic regulations must be followed in full at all times. This applies in particular with regard to the use of the exterior mirrors and looking over one's shoulder when turning corners, turning round and changing lanes.

The PreView[®] system is an object detection system and must not be considered a decisive factor for safe operation of the vehicle. It must be used in conjunction with established safety programmes and procedures to increase the operational safety of the vehicle and to protect both individuals and nearby objects.

Before commissioning, the function tests must be carried out in accordance with Chapter 5.4 of this operating manual.

The system is activated when the ignition is switched on.

6 Operation

WARNING!



Danger to life and serious physical injury and damage to property.

There is a danger to life, of serious physical injury and damage to property due to the operation of the system if it is not ready for operation or if it malfunctions. This can cause the driver to perform driving manoeuvres that endanger him or her, any passengers and other road users.

- > The installation instructions given in Chapter 5.1 of this operating manual as well as in the installation manual must be observed in full and without fail.
- > Carry out the function tests according to Chapter 5.4 of this operating manual before each journey.
- > Make sure that the status LED of the display is green (i.e. system ready for operation).

WARNING!



Danger to life and serious physical injury and damage to property.

There is a danger to life and of serious physical injury to vehicle occupants and other road users as well as a danger of damage to vehicles if the driver fails to comply with the road traffic regulations.

- > Road traffic regulations must be followed in full at all times. This applies in particular with regard to the use of the exterior mirrors and looking over one's shoulder when turning corners, turning round and changing lanes.

WARNING!



Danger of serious physical injury.

The risk of serious physical injury due to prolonged presence within the detection range of the radar sensor cannot be discounted.

- > Avoid staying within the detection range of the radar sensor for hours while it is active.

6.1 Normal operation

6.1.1 General points

The PreView® Side Defender®II radar system is a blind spot collision warning system designed to supplement other safety practices and/or devices. It does not relieve the driver of his or her responsibility to ensure before driving manoeuvres that no personal injury or damage to property can occur - the driver always has prime responsibility to ensure the safe operation of a vehicle. It should also be noted that in some traffic or weather situations, the system may also trigger incorrect messages. (See Chapter 2.10).

The Side Defender®II system detects moving objects such as cyclists and vehicles in the adjacent lane, while ignoring stationary objects such as crash barriers, parked cars and people standing or moving very slowly at the side of the road. The detection zone of the Side Defender®II is 5 metres to the left and 5 metres to the right when the vehicle is stationary and 3 metres in front of the sensor. When the vehicle is moving, the detection zone is extended to 6 metres to the left and right and 3 metres in front of the sensor.



Before starting a journey, the volume of the display must be adjusted by pressing the volume control so that the audible alert will be perceived by the driver while driving despite any secondary noise sources (radio, on-board radio communications, traffic noise, etc.) in such a way that the driver can safely operate the turning assistant system in the vehicle (see Chapter 3.6 for details of operation).

The PreView Side Defender®II can detect most objects in the detection zone. However, there are circumstances in which objects can evade detection. It is essential that the user becomes familiar with the capabilities and weaknesses of the system, which are described in Chapter 3.4.

Before the start of each journey, the pre-trip checks must be carried out in accordance with Chapter 5.4.

The system is activated when the ignition is switched on.

At system start-up, the display runs through a power-up sequence to check all the connections and confirm proper communication with the sensor. The display will beep to confirm normal operation of the system.

6.1.2 Urban traffic mode

At speeds up to and including 30 km/h, Side Defender®II operates in city mode, giving priority to warning the driver of cyclists in the detection zone. If a moving object is detected, the display in the cab gives a visual alert. Both audible and visual alerts are triggered when the direction indicator is active and a moving object is detected. Stationary objects such as road signs, parked cars and pedestrians standing at the side of the road or moving very slowly are ignored.

The PRECO PreView Side Defender®II turning assistant, AAS-GPS / AAS-CAN, is designed to support right turns in inner-city traffic for commercial vehicles over 3.5 t. It detects, within the limits of the system, cyclists and pedestrians who are in a defined area to the right of the vehicle.

6.1.3 Cruising speed mode

At speeds above 30 km/h, Side Defender®II gives priority to warning of moving objects in the adjacent lane. Stationary objects such as crash barriers, concrete barriers and pedestrians standing at the side of the road or moving very slowly are ignored in order to prevent unnecessary alerts. This mode is intended to reduce the risk of collision due to reduced visibility (blind spot) when changing lanes and getting into the right lane.

6.1.4 Muting

The AAS 1312 is designed to warn the driver of unprotected road users next to the vehicle when turning right. There are, however, situations in which - despite the direction indicator being activated - there is no intention to turn right. For this reason there is the possibility to mute the signals for these situations (e.g. passengers boarding with the bus door open). This function is preset by the manufacturer using predefined variables. Visual detection corresponds to the display when the right-hand direction indicator is activated.

For the same reason, the AAS-CAN mutes the audible warning tone when the hazard warning lights are active.

6.2 Control and monitoring

The following table gives an overview of the signal types and display indications:

Components :	Description
Status LED	Steady green after the system is turned on.
Speaker	The faster the audible alert signal is repeated, the closer the detected object is. The audible alert signal refers to the nearest detected object.
Indicator LEDs	These LEDs provide information on the operating status of the system and indicate any faults. Furthermore, alerts are visualised through the LEDs.
Volume control	The operator can select five different volume levels with this button. The last level selected is the one saved by the system.

The following messages on the display LEDs are possible (for the numbering of the LEDs see Figure 15):

Right indicator inactive: Two LEDs light up yellow (No. 2 & 4)

Right indicator active: Two LEDs light up red (Nos. 2 & 4).
Two LEDs light up yellow (Nos. 1 & 5)
Additional audible alert

In the AAS-GPS & CAN turning assistant systems, only the right-hand LEDs **1 & 5** and **2 & 4** are active at any one time (driving on the right).

Additional sensors (of the types Side Defender II or Sentry) can be connected to the displays. These are available as separate accessories. The indicator LEDs allow the individual sensors around the vehicle to be assigned.

Typical LED display modes for additional sensors:

Front sensor:	LEDs 11 & 1	right side monitoring:	LEDs 2 & 4
Rear space sensor:	LEDs 5 & 7	left side monitoring:	LEDs 8 & 10

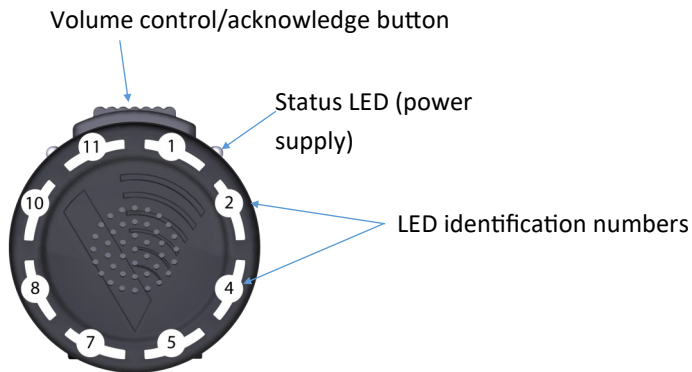

Fig. 15: Controls and indicator LEDs on the display

6.3 Unusual situations

WARNING!



Danger to life and serious physical injury and damage to property.

There is a danger to life and of serious physical injury to vehicle occupants and other road users as well as a danger of damage to vehicles if the driver fails to comply with the road traffic regulations.

> Road traffic regulations must be followed in full at all times. This applies in particular with regard to the use of the exterior mirrors and looking over one's shoulder when turning corners, turning round and changing lanes.

The PreView Side Defender®II can detect most objects in the detection zone. The system cannot detect objects outside the detection zone. However, there are circumstances in which objects in the detection zone also elude detection. All stationary or slow-moving objects such as crash barriers, parked cars and stationary or slow-moving people will not be detected. People and cyclists who step out from between closely parked cars or other stationary objects may also not be detected.

Further details on the detection capabilities of the system are described in Chapter 3.4.

The position of the objects in relation to the radar sensor also influences the likelihood of their being detected. Objects and people whose narrow side is facing towards the radar sensor may not be detected. See also Fig. 1 in Chapter 3.4.

WARNING!



Danger to life and serious physical injury and damage to property.

There is a danger to life, of serious physical injury and damage to property if the system is operated when it is malfunctioning. This can cause the driver to perform driving manoeuvres that endanger him or her, any passengers and other road users.

> Carry out the function tests according to Chapter 5.4 of this operating manual before each journey.
> Make sure that the status LED of the display is green (i.e. system ready for operation).
> In snow, slush and in very dusty environments, expect incorrect messages from the turning assistant.

Snow, slush and very dusty environments can contaminate the radar sensor and cause the device to issue error messages or fail to detect moving objects and people.

7 Troubleshooting

WARNING!



Danger to life and serious physical injury and damage to property.

There is a danger to life, of serious physical injury and damage to property when working on the on-board electronics.

- > Adhere to good engineering practice
- > Comply with all applicable safety rules:
 1. Disconnect
 2. Secure against restarting
 3. Check to ensure all poles are voltage free
 4. Ground and short circuit
 5. Cover or fence off adjacent live parts

In the event of system faults, the following points must first be checked

- Ensure that the sensor is free of dirt on the surface, on the top and bottom.
- Ensure that the radar sensor is actively connected to a direct current supply (9-33 V).
- Make sure that all the wires and cables are connected between the display and the sensor.
- Make sure that the system and sensor status are shown on the display.
- Make sure that the display status LED is green.

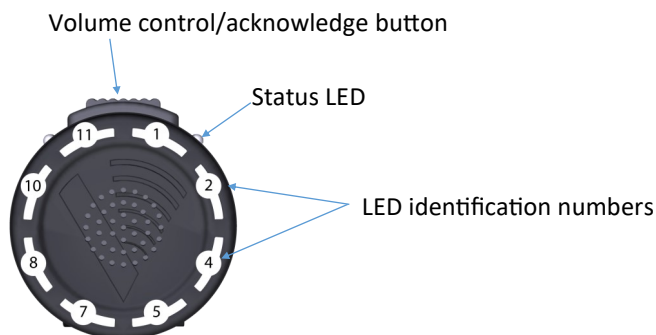

Fig. 16: Controls and indicator LEDs on the display

List of error messages

The following table is intended to provide assistance in detecting and, if necessary, correcting faults yourself. If a malfunction that cannot be easily remedied on site occurs with PreView® Side Defender®II, you should visit a MEKRA Lang-trained workshop or contact MEKRA Lang Customer Service (for contact information, see Chapter 10.1).

Error description	Possible cause	Corrective action
Display LEDs 2, 4 and 8, 10 are lit continuously orange	The display is not receiving the speed message from the vehicle (via GPS or CAN).	This error message can be deleted by holding down the acknowledgement button (approx. 3 seconds). However, stationary objects will not be ignored until the display receives the speed message again.
Two display LEDs flash alternately yellow and red	A sensor located on the side to which the flashing LEDs refer (left, right) is not communicating with the display.	Check the cable connection to the sensor and ensure that the sensor is being supplied with power. If the error continues to be displayed, MEKRA Lang should be contacted.
The detection LEDs always light up when the sensor is installed	The sensor has been installed in such a way that other parts of the vehicle project into its detection zone.	Ensure that the sensor is facing away from the vehicle towards an open area without obstacles. This may require removing the retaining screws and lifting the sensor away from the side of the vehicle. If the detection LED is not active when moved away from the vehicle, but is active when the sensor is attached to the vehicle, the sensor must be installed in a different location.
Audible detection signal sounds when the direction indicator is not active	The wire in the harness for the direction indicator is being influenced by other electronic circuits, e.g. daytime running lights, air brakes, etc.	Check the conductor connection of the direction indicator.

Error description	Possible cause	Corrective action
Audible detection signal sounds when reversing without a moving object in the detection zone	The wire in the reverse gear harness may not be connected properly or may be affected by other electronic circuitry.	Check connections and wiring.
Display LEDs 5 and 7 are lit continuously red	BIST (built-in safe test) system error.	Contact MEKRA Lang.
Display LEDs 5 and 7 are lit continuously yellow	The sensor is too dirty and is not working properly.	Clean the sensor.

8 Care and maintenance

WARNING!



Danger to life and serious physical injury and damage to property.

There is a danger to life, of serious physical injury and damage to property when working on the on-board electronics.

- > Adhere to good engineering practice
- > Comply with all applicable safety rules:
 1. Disconnect
 2. Secure against restarting
 3. Check to ensure all poles are voltage free
 4. Ground and short circuit
 5. Cover or fence off adjacent live parts

WARNING!



Danger of serious physical injury.

The risk of serious physical injury due to prolonged presence within the detection range of the radar sensor cannot be discounted.

- > Avoid staying within the detection range of the radar sensor for hours while it is active.

Note!

Danger of damage to property.

Risk of damage to property due to non-compliance with the maintenance intervals and improper maintenance.

- > Ensure maintenance intervals are adhered to.
- > Ensure complete and proper maintenance.

General notes

Note: the system must be visually inspected on a daily basis to ensure correct operation and to familiarise the operator with the detection zone. In addition, before the start of each journey, the pre-trip checks must be carried out in accordance with Chapter 5.4. These checks must be carried out without fail:

- Check exposed wiring and cables for visible damage
- Check that the plug connections for the system cables are properly fitted
- Check the radar sensor for dirt and clean it if necessary.

More frequent inspections are required in the following cases:

- If the device is used in particularly dirty or harsh environmental conditions
- If the operator reasonably assumes that the system is damaged.

Cleaning

The radar sensor must be cleaned with clear water. No cleaning agents or abrasive cleaners containing solvents may be used. When cleaning, it is recommended not to use a high-pressure cleaner and to switch off the ignition despite ingress protection class IP69K.

Clean the display with a suitable microfibre cloth.

9 Disposal

The packaging materials consist largely of recycled and recyclable material. The packaging should be recycled in an environmentally friendly manner as part of the disposal process.

Waste equipment and components can be handed in at recycling points or sent to the manufacturer.

10 Service

10.1 Customer service

Customer Service is responsible for repairs, warranty claims, and the naming of MEKRA Lang trained workshops:

MEKRA Lang GmbH & Co.KG

Buchheimer Str. 4,	Phone	+49 9847 989 0
91465 Ergersheim	Fax	+49 9847 989 112
Germany	info@mekra.de	
	www.mekra.de	

Furthermore, customers can contact the customer service of the manufacturer PRECO Electronics® in the event of technical problems:

PRECO Electronics®

10335 W. Emeralds St.	Phone	+1 (208) 323 1000
Boise, Idaho 83704	Fax	+1 (208) 323 1034
USA	www.precos.com/contact-us/	

A safety expert will respond within 24 hours.

10.2 Accessories and consumables

The PRECO PreView Side Defender®II turning assistant system, AAS-GPS / AAS-CAN is a stand-alone radar sensor system. The radar technology ensures reliable operation in almost all weather and environmental conditions.

It can be supplemented at any time with a MEKRA Lang camera monitor system. This enables the driver additionally to see the objects detected by the radar. Other cameras can also be integrated: from the rear view camera to a 360° panoramic view.

Additional accessories are available on request.

Contact us!

10.3 Replacements and spares

The components included in the scope of delivery (Chapter 3.1) can also be ordered separately from MEKRA Lang.

MEKRA Lang GmbH & Co.KG

Buchheimer Str. 4,
91465 Ergersheim
Germany

Phone +49 9847 989 0
Fax +49 9847 989 112
info@mekra.de
www.mekra.de

031312001000/Rev02 • 12/2019

